



clarion

Owner's manual

OHM875VD
OHM1075VD
OHM1575VD

OVERHEAD MONITOR SYSTEM WITH DVD PLAYER





English

Thank you for purchasing this **Clarion** product.

- Please read this owner's manual in its entirety before operating this equipment.
- After reading this manual, keep it handy, such as in your glove compartment.
- Save your sales receipt. The warranty at the end of this manual and your sales receipt are essential for warranty service.

FCC Approval

The Clarion OHM875VD / OHM1075VD / OHM1575VD products have been tested and found to comply within the limits of a Class B digital device, pursuant of Part 15 of the FCC rules. These limitations are designed to provide reasonable protection against harmful interference in a residential installation. This equipment generates and uses radio frequency energy and if not installed and used in accordance with the instructions, may cause harmful interference to radio communications.

There is no guarantee that interference will not occur in a particular installation. If this equipment does cause harmful interference to a radio or television reception, turn off the equipment and contact a local Clarion Dealer for assistance. Changes or modifications to this product not approved by the manufacturer will void the warranty and violate FCC Approval.

Contents

FCC Approval.....	2
1. FEATURES.....	4
Image features	4
DVD video features	5
Other features	5
2. PRECAUTIONS.....	6
Operating	6
General	6
Maintenance.....	7
Installation	7





3. CONTROLS..... 8
 Monitor closed..... 8
 DVD drive slot..... 9
 Monitor open 10
 Remote control..... 11

4. OPERATIONS 12
 Opening the monitor..... 13
 Closing the monitor 13
 Handling discs 14
 Turning the player on..... 14
 Turning the player off..... 14
 Changing the image aspect ratio 14
 Playing a disc (DVD or CD) 15
 Using headphones 15
 Playing DVDs 17
 Playing audio CDs..... 21
 Playing MP3s 22
 Care and maintenance..... 23
 Changing the battery in the remote control 24

5. INSTALLATION AND WIRING 25
 What is included in the box 25
 Tools and additional components 25
 Before you begin 26
 Mounting and wiring precautions 26
 Installation procedure 27
 Wiring diagram 30

6. SETTING PREFERENCES 30
 Accessing the on-screen display menus 30
 Example: Setting parental control 31
 General setup page..... 32
 Speaker setup page 32
 Preference page..... 33

7. TROUBLESHOOTING..... 34

8. GLOSSARY..... 37

9. SPECIFICATIONS..... 38



1. FEATURES

WARNING

The Clarion OHM875VD / OHM1075VD / OHM1575VD overhead monitor players are designed strictly for rear-seat entertainment. Viewing the monitor while operating a motor vehicle can result in serious injury and/or property damage. Clarion is not responsible for any injury and/or property damage as a result of the improper use or viewing of the monitor.

The Clarion OHM875VD / OHM1075VD / OHM1575VD overhead monitor players are engineered with advanced technological designs and components to combine flexibility with reliability, and expandability for the best picture quality and ease-of-use.

Flexibility

Designed primarily for rear seat entertainment, the audio from a OHM875VD / OHM1075VD / OHM1575VD can be enjoyed privately through wireless headphones and/or incorporated into any head unit.

Reliability

High-grade electronic components and heightened electronic connections provide years of service in extremely harsh, mobile environments.

Expandability

The player's built-in audio/video (A/V) connectors allow you to add multiple A/V sources.

Image features

- Flip-down thin film transistor (TFT) active matrix display with screen width that depends on the model:

OHM875VD: 8.0"

OHM1075VD: 10.2"

OHM1575VD: 15.4"

- WVGA LCD with 16:9 or 4:3 aspect ratios
- Screen resolution depending on the model:
 - OHM875VD: 800 x 480 pixels
 - OHM1075VD: 800 x 480 pixels
 - OHM1575VD: 1024 x 768 pixels
- NTSC and PAL support



- Wide viewing angle (up/down/left/right) for all three models:
OHM875VD and OHM1075VD: 45/55/65/65
OHM1575VD: 10/30/40/40
- Manual display angle adjustment: vertically adjustable up and down with a maximum angle of 150 degrees
- Adjustable color, contrast brightness, and hue (PAL) or tint (NTSC)
- On-screen display (OSD) of configuration options

DVD video features

- DVD drive that supports the following formats:

	DVDs	12cm
	Vedio CDs	12cm
	Audio CDS	12cm
	MP3 CDs	12cm

- Playback of CDs with two recorded sessions (one audio and one data).
- Multi-sound (Ⓜ): DVD audio that supports up to eight languages per film
- Multi-angle function (Ⓜ): for DVDs that provide multiple views of the same scene
- Subtitles (Ⓜ): support up to 32 languages
- The playback of MP3 music files stored on a CD-R/CD-RW disc
- Region number assigned based on the sales area; region number is indicated on the box as follows:



Other features

- Roof mounting
- Automotive start-up protection
- 2 audio/video inputs and 1 audio/video output
- White LED built-in dome light
- Built-in IR transmitter for IR wireless headphones
- IR remote control
- Slot-in DVD mechanism





2. PRECAUTIONS

Failure to observe these precautions may damage your car, the monitor, or the video source, and may void the warranty.

For questions or problems not covered in this manual, contact your local Clarion Dealer.

Operating

- Do not operate this product in ways other than those described in this manual. Failure to follow instructions may void the warranty.
- Do not use the unit with the ignition off. This could drain the car's battery.
- If the internal temperature of the vehicle is extremely high (over 50 degrees Celsius), let the unit cool down a bit before you use it.
- If the temperature in the car is very low (below -5 degrees Celsius), starting the unit right after you start the car with its heater running may cause moisture to form on the LCD. Turn the unit off immediately! Failure to do so may cause an electrical short. Allow about one hour for the condensation to dissipate before using the unit.
- In extremely cold temperatures the picture may appear dark and move slowly. The display returns to normal when the temperature rises.
- When using the system, make sure you are seated with your seat belt fastened. Otherwise, you may hit your head on the unit if the driver breaks suddenly. In an accident, injuries can be more severe if your seat belt is not fastened.
- Before leaving the car, eject the DVD disc and store it separately away from direct sunlight. Heat and humidity can damage DVD discs causing them not to play.

General

- Do not leave the monitor extended when you're not using it. Direct sunlight can cause the monitor to malfunction.
- Do not hang onto or hang items from the overhead monitor.





- Do not pour liquid into the unit or poke foreign objects into the DVD drive slot. Water, humidity, and foreign objects may damage internal circuitry.
- If the unit becomes wet, turn off all power and ask your authorized Clarion Dealer to clean or service the unit.
- Do not drop the unit or hit the LCD panel with a hard object. You may cause permanent damage.
- If the LCD breaks, avoid touching the glass and fluid. If you do touch the fluid, clean it off your body and/or clothes with plenty of water, then get medical attention.

Maintenance

- Do not clean the surface of the LCD with chemical solvents or corrosive detergent. Permanent damage to the screen may result.
- Do not disassemble or modify this unit. You may damage the monitor, void the warranty, and suffer electric shock.

Installation

Installation of mobile audio and video components requires experience with a variety of mechanical and electrical procedures. Although this manual provides general installation and operation instructions, it does not show the exact installation methods for your particular vehicle.

If you do not have the required knowledge, experience, and/or tools to successfully complete the installation, consult an authorized Clarion Dealer about professional installation options.





3. CONTROLS

Monitor closed

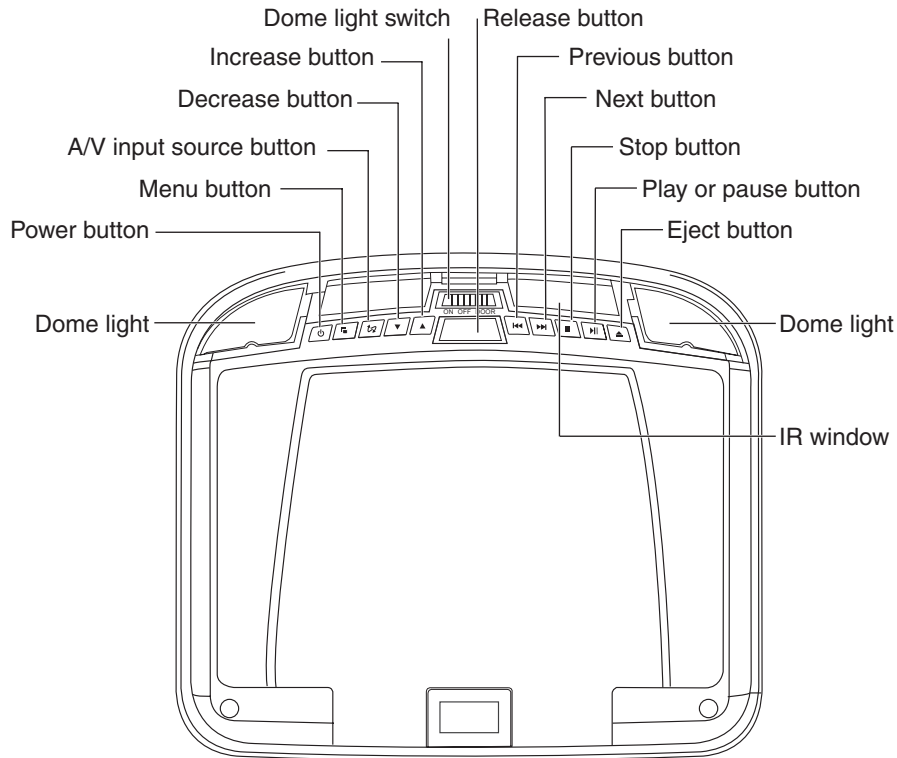

Looking up from directly below at the player with the LCD panel closed

Quick reference to controls with monitor closed

- Audio/video input source (**A/V**) Selects the video input source: DVD-IN, AV IN1 or AV IN2
- Decrease button (-) Reduces a value in a menu, such as the volume.
- Dome light Provides an interior light for the vehicle.
- Dome light switch Configures the dome light: ON, OFF or door activated. To manually turn the light on or off, move this switch to the ON or OFF positions. In the door-activated position, the dome light turns on and off when you open and close the car door.





Note:

The dome light switch works only when the green dome light wire is connected to the door sensor and the polarity switch is set correctly. See the vehicle's wiring manual for connection details.

- ▲ Eject button (**EJECT**) Ejects the disc.
- ▲ Increase button (+) Increase a value in a menu, such as the volume.
- IR window Receives infrared (IR) signals from the remote control and sends IR signals to the headphones.
- Menu button (**MENU**) Opens the Display menu. Press again to sequentially select each menu item.
- ▶▶ Fast Forward button (**FF**) Skips to the next chapter on a DVD or track on a CD. Press and hold to fast forward at 2x, 4x, 8x, 16x and 32x speeds.
- ▶|| Play/pause button (**PLAY**) Plays or pauses the disc.
- ⊖ Power button (**POWER**) Turns power to the player on and off.
- ◀◀ Rewind (fast reverse) button (**REW**) Skips to the previous chapter on a DVD or track on a CD. Press and hold to fast reverse at 2x, 4x, 8x, 16x and 32x speeds.
- Release button Opens the LCD panel.
- Stop button (**STOP**) Press once to stop playback. Then, to resume where the player left off, press the play/pause button.

Press this button twice to fully stop playback. Then, to start playing at the beginning of the disc, press the play/pause button.

DVD drive slot

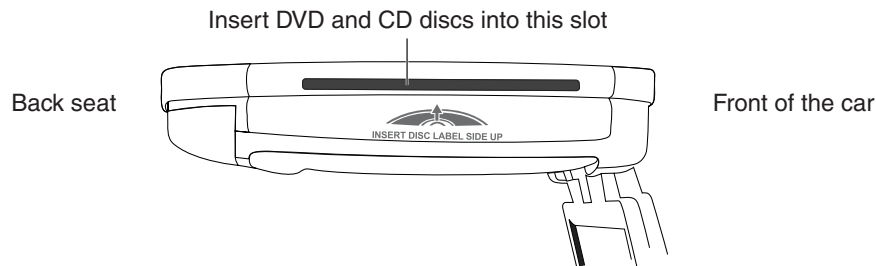

View of the player from the front seat, passenger's side





English

Monitor open

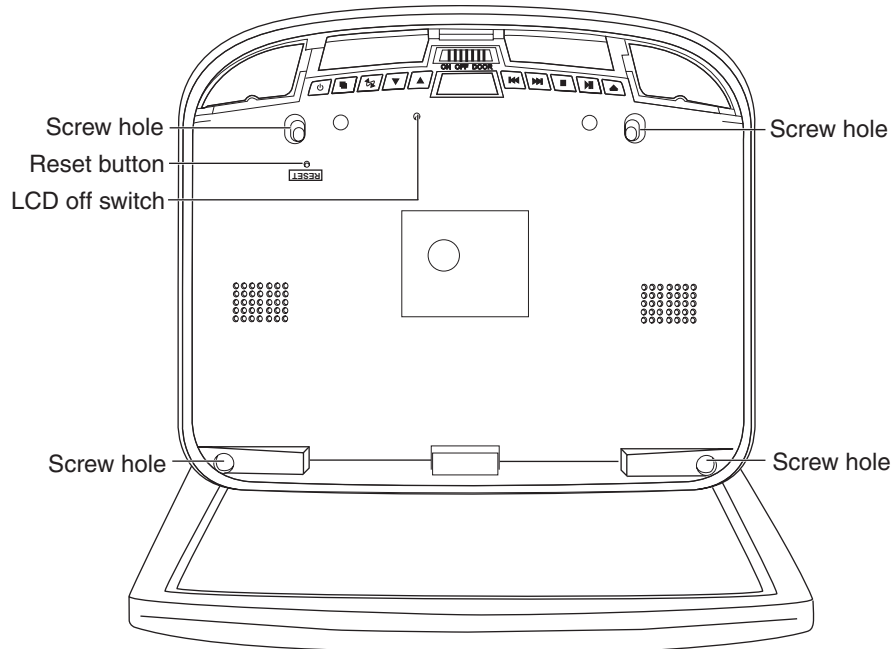

Looking up from directly below at the player with the LCD panel open

Quick reference to controls with monitor open

- LCD off switch Turns off the LCD screen.
- Reset button Press with a pencil or other narrow-tipped tool to return all setup options to their factory default values.
- Screw holes Used to attach the player to the mounting plate.





Remote control

English

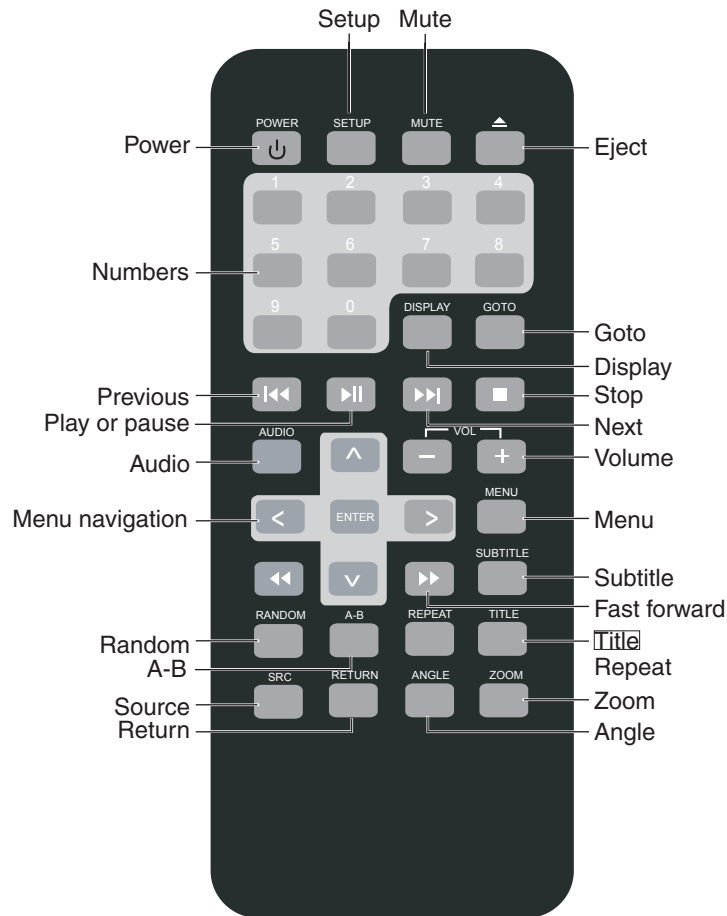

Remote control

Quick reference to remote control

- A-B** Repeats playback from previously identified points A to B.
- Angle** Changes a scene angle when playing back a DVD that includes multiple scene angles.
- Arrows** Selects options on DVD menu and values on Display menu.
- Audio** DVD: Changes the language during playback. For a VCD/CD: Changes audio channel (left, right, stereo) during playback.
- DISPLAY** Displays playback information: title, chapter, track and time.



- ENTER** Accepts settings selected using the arrow keys.
- ▲ Eject** Ejects the current disc in the slot.
- ▶▶ Fast forward** Speeds playback forward at 2x, 4x, 8x, 16x and 32x speeds.
 - Goto** Starts playback at the selected chapter, track or time.
 - Menu** Displays the DVD's main menu. Press and hold to view the Display menu.
 - Mute** Disables and enables sound.
 - Next** Jumps to next chapter on a DVD or to next track on a CD.
 - Numbers** Used to directly enter track numbers and to configure some options.
- ▶|| Play or pause** Starts and stops playback of a DVD or CD.
 - Power** Turns the player on and off.
- ◀◀ Previous** Jumps to previous chapter on a DVD or previous track on a CD.
 - Random** Plays back chapters or tracks in random order.
 - Repeat** Alternates among repeat options. For a DVD: 1x Chapter, 2x Title, 3x All. For a CD: 1x Track, 2x All.
 - Return** Single press returns to main menu; second press returns to last position of playback.
- ◀◀ Rewind (fast reverse)** Fast reverses playback at 2x, 4x, 8x, 16x and 32x speeds.
 - Setup** Accesses the setup menu used to modify player options.
 - Source** Selects the video input source: DVD-IN, AV IN1 and AV IN2.
 - Stop** Stops playback. Then press the play/pause or **ENTER** buttons to resume playing back at last position. Press the stop button twice to fully stop playback, then press the play or **ENTER** buttons to start playing back at the beginning of the DVD.
 - Subtitle** Turns pre-recorded subtitles on and off.
 - Title** Displays the DVD's title menu.
 - Volume)** Decreases and increases the volume.
 - Zoom** Zooms in when viewing a movie or photographs. As you press **ZOOM**, the player alternates among the available zoom settings (2x, 3x, 4x, 1/2x, 1/4x and normal).

4. OPERATIONS

The monitor and DVD player provide the video; headphones provide the audio. The unit receives power from the power connector used for the car's dome light, which the unit replaces.



Opening the monitor

1. Press the release button to open the overhead monitor screen.

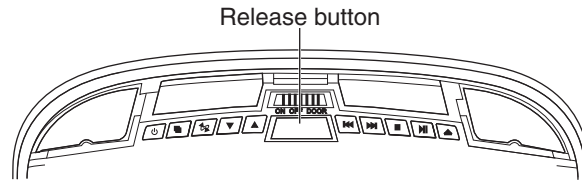

Looking up at the monitor from directly below

2. Gently swing the LCD down and adjust the angle for viewing.

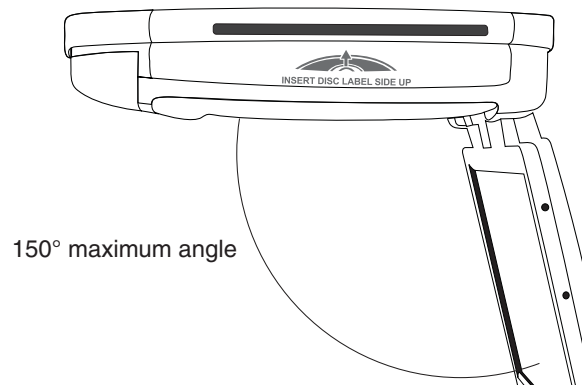

Monitor open

CAUTION

The LCD opens to a maximum angle of 150 degrees. Do not attempt to open it further.

The monitor turns on automatically when you fully open it (assuming the ignition switch is on or in the ACC position).

Closing the monitor

Gently push the back side of the LCD until it clicks into the overhead housing. The monitor turns off automatically when you return it to the closed position.

Note:

When closing the LCD panel, do not let cords or other items get caught between the LCD and the overhead housing. Doing so can seriously damage the TFT screen.

For safety, close the LCD panel when you are not using it.





Handling discs

- To keep a disc clean, do not touch the play side (non-label side).
- Do not attach sticky notes to or put tape on a disc.
- Keep discs away from direct sunlight and heat.
- Store discs in a protective disc case.
- Before playback, wipe the disc outwards from the center with a clean cloth.



Turning the player on

1. Turn the ignition to either ACC or ON.
2. Press the power button (⏻) on the player or on the remote.
If no disc is in the drive, it displays: "NO DISC."
4. To change input sources, press SRC and alternate among A/V input sources: DVD-IN, AV IN1 (first additional audio-video source) and AV IN2 (second audio-video source). Additional AV sources must be connected.



Note:

You cannot insert a DVD into the slot if you've selected an alternate audio-video source (AV IN1 or AV IN2).

Turning the player off

To turn the power off, press the power button (⏻).

If a CD or DVD is playing when you turn the power off and back on again, the player continues playback from where you stopped.

Note:

Once the player is turned off, you cannot eject a DVD or CD left in the slot.

Changing the image aspect ratio

A common display setting to change is screen mode, which controls the aspect ratio used to display images.

Do not leave the headphones in a place that is subject to direct sunlight or extreme temperatures.

An IR receiver in the headphones that is exposed to direct sunlight for an extended period of time may cause poor sound quality. Let the headphones cool off before you use them.





Playing a disc (DVD or CD)

1. Put the headphones on your head and turn the headphone power on.
2. Assuming the power is on, insert a DVD into the player.
The player displays "Loading."
3. Aim the remote control directly at the IR receiver on the player and press the play/pause button (▶||) or press **ENTER** (on the remote).

Using the remote control

- Use the remote control only inside the vehicle.
- Use the remote control no further than five feet (three meters) from the sensor.
- Direct sunlight (or a very bright light) reduces sensitivity to remote signals. Do not use the player in direct sunlight.
- Any object that comes between the infrared sensor and the remote control may disrupt reception.

Controlling playback

- To pause and resume, press the play/pause button (▶||).
- To stop playback, press the stop button (■).
If you press the stop button (■) and then press the play/pause button (▶||) again, playback begins from the beginning of the last chapter played, not the last exact location when you interrupted playback.
- To play back the previous track or chapter, press the previous button (◀◀).
- To play back the next track or chapter, press the next button (▶▶).
- To remove the CD or DVD, press the eject button (▲).
- To mute the sound, press the **MUTE** button on the remote. Press this button again to enable sound again.

Using headphones

To hear the audio requires headphones.

WARNING

Do not use the headphones while driving.





English

Headphone components

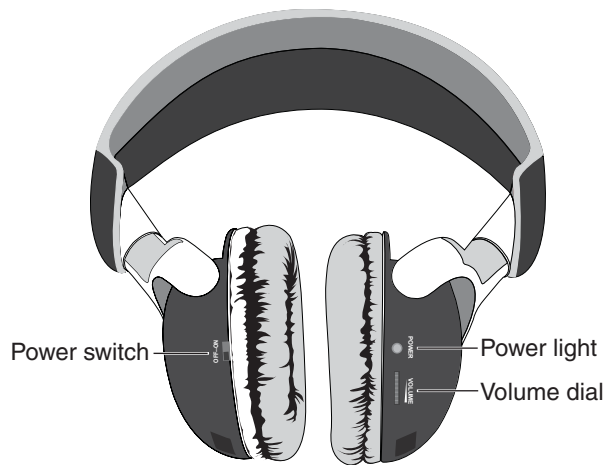

Headphones

Installing batteries in the headphones

If this is the first time you're using the system, install batteries in the headphones. Change the batteries when you begin to hear distorted audio that cuts in and out.

1. Rotate the left earpiece so the battery cover is accessible.
2. Slide the battery cover down.
3. If replacing the batteries, remove the discharged batteries.
4. Insert the new AAA batteries according to the polarity marked inside the battery compartment.
5. Slide the battery cover back into place.



Battery cover

Close-up of the left earpiece

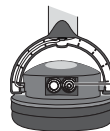

Batteries installed

Close-up with batteries installed

Setting the volume

The volume control is on the headphones. Turn the volume dial up or down.

Note:

Some noise may be audible depending on the type of encoder software used while recording. This noise is not caused by the OHM875VD / OHM1075VD / OHM1575VD.





Direct sunlight and temperature extremes

Do not leave the headphones in direct sunlight or extreme temperatures.

Playing DVDs

Accessing the root menu

A DVD is divided into titles and chapters. The root menu shows the contents of the disc. Some DVDs only allow you to select disc playback options from the DVD root menu.

To access the root menu of the DVD, press the **MENU** button during playback.



DVD root menu

Status information

To view status information about the current viewing session, press the **DISPLAY** button continuously to cycle through the following information.

TITLE ELAPSED		
TT 01/04	CH/25	0:02:10
TITLE REMAIN		
TT 01/04	CH/25	0:03:10
CHAPTER ELAPSED		
TT 01/04	CH/25	0:03:40
CHAPTER REMAIN		
TT 01/04	CH/25	0:03:40

Status information

Changing languages

Note:

All audible languages must be pre-recorded on the DVD. Some DVDs only allow language access through the DVD menu.

- To change the audible language, press the **AUDIO** button on the remote.
The player displays the current language number and name, and the total number of languages available.





English



Sample language option

- To cycle through all available languages, continue pressing the **AUDIO** button.
The audio information disappears automatically if you wait three seconds.

Using subtitles

Language subtitles are normally off.

Note:

Subtitles must be on the DVD. Some DVDs only allow subtitle access through the DVD menu.

- To turn subtitles on, press the **SUBTITLE** button.
The player displays the current language number and name, and the total number of languages for which subtitles are available.



Sample subtitle option

- If the DVD provides subtitles in multiple languages, continue pressing the **SUBTITLE** button to change the subtitle language.
- To turn subtitles off, press the **SUBTITLE** button until the screen displays “subtitle off.”
The display of the subtitle options disappears automatically if you wait for three seconds.





Repeating DVD chapters and titles

To repeat a chapter, title or both, during playback continue pressing **REPEAT** to alternate among options.



Sample repeat option

- Chapter repeats the current chapter.
- Title repeats the current title.
- All repeats all chapters and titles.
- Off resumes normal playback.

Repeating favorite sections

To repeat a favorite section you must first mark where it begins and ends.

1. Play back the DVD.
2. To identify the beginning of your favorite section (point A), press the **A-B** button when the section starts playing back.
3. To identify the end of your favorite section (point B), press the **A-B** button again when play back reaches the end of the section.

To repeat this section, press the **A-B** button on the remote.

To cancel the repeat playback and resume normal playback, press the **A-B** button again.

Changing viewing angle

Note:

Multiple angles must be pre-recorded on the DVD. Look for the multiple angles icon (⊕) on the jacket of the DVD.

- To cycle through the available viewing angles, press the **ANGLE** button on the remote while playing back the DVD.

The player displays the current angle number and the total number of angles available.





English

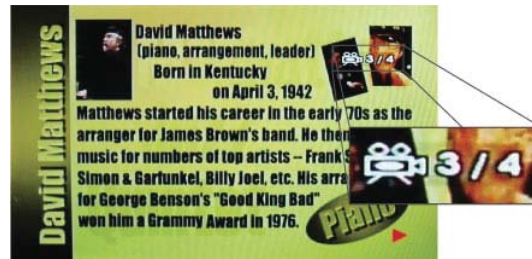

Sample angle options

- To change the angle, press the **ANGLE** button again.
- To return to normal viewing, press the **ANGLE** button again.

Zooming in and out

- To zoom in (enlarge) the image when watching a DVD, press **ZOOM** during playback.

As you press **ZOOM** on the remote, the player alternates among the available zoom settings (2x, 3x, 4x, 1/2x, 1/4x and normal).

- To zoom in when viewing photographs (JPEG/JPG images) stored on a disc, press **ZOOM** on the remote, then press (▶) or (◀) to alternate among zoom settings (2x, 3x, 4x, 1/2x, 1/4x and normal).



Adjusting picture quality



1. Press and hold the **MENU** button on the remote for more than one second (may require as many as three seconds).

The player displays the "Operation Menu."

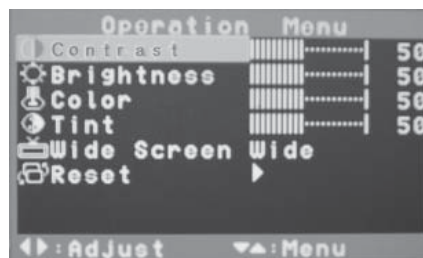

Setup options

2. Press the **MENU** button again to alternate among the available options:

- Contrast** Adjusts the differences between the light and dark areas of the image.
- Brightness** Makes the whole image lighter or darker.
- Color** Adjusts color based on the color spectrum.





- Tint** Adjusts the intensity of the color when in NTSC mode (to play back DVDs recorded in the United States).
- Wide Screen** Selects the aspect ratio (width vs. height) of the image. Options are Wide (16:9) and Normal (4:3) for the OHM875VD and OHM1075VD. The OHM1575VD provides two additional options: Panorama and Zoom.
- Wide stretches images horizontally so they fit the entire screen. This may distort the images slightly. Normal mode displays without distortion, but the image does not fill the entire screen.
- On the OHM1575VD, Panorama expands the left and right sides of the image. Zoom expands images horizontally and displays them to fit the entire screen. The expansion ration increases towards the right and left edges of the screen.
- Reset** Returns all menu values to their default settings.

3. Press the left (<) and right (>) arrows on the remote to change the values of selected options.

Playing audio CDs

Displaying CD information

To display the playing time and current track, press **DISPLAY** on the remote during CD playback.

Continue pressing **DISPLAY** on the remote to view the disc type, current time, current track number, and total number of tracks.

Repeating CD tracks

To repeat a track or the entire CD, press **REPEAT** on the remote during playback.

To cycle through the available options, continue pressing **REPEAT**.

- Track repeats the current track.
- All repeats the current CD.
- Off resumes normal playback.

Repeating favorite sections

To repeat a favorite section you must first mark where it begins and ends.

1. Play back the CD.
2. To identify the beginning of your favorite section (point A), press the **A-B** button on the remote when the section starts playing back.
3. To identify the end of your favorite section (point B), press the **A-B** button again when play back reaches the end of the section.





To repeat this section, press the **A-B** button on the remote.

To cancel the repeat playback and resume normal playback, press the **A-B** button again.

Playing MP3s

MP3, a format for storing digital audio, compresses each audio track with little loss of audio quality. The result takes up much less disc space than the track would without MP3 compression. The OHM875VD / OHM1075VD / OHM1575VD player supports CD-R/RW and DVD-R discs that contain music MP3 files.

MP3 icons



This icon in front of an item identifies a folder.



This icon in front of an item identifies the item as an MP3 file.

Procedure

1. Insert a CD that contains MP3 files into the player.
The player displays the MP3 menu.
2. To select the folders and tracks to play, press the **DISPLAY** button on the remote.
The player displays the folder structure.



MP3 folder structure with selected folder highlighted

3. To choose a folder from the list, press the up and down arrow keys on the remote.
4. Press the **ENTER** button on the remote.
The player displays the contents of the selected folder.





English

Folder contents

5. To select the MP3 file, press the up and down buttons on the remote.
6. To play the file, press the **ENTER** button on the remote.

MP3 controls

- To play back to the next MP3 file, press the next button (▶▶).
- To play back the previous MP3 file, press the previous button (◀◀).

Repeating MP3s

To repeat a single MP3 file, press the **REPEAT** button on the remote. To cycle through all the following settings, continue to press **REPEAT**.

- Repeat single repeats the current file.
- Repeat all repeats the contents of the current folder.
- Repeat off turns off repeat and resumes normal playback.

Care and maintenance

Cleaning the monitor

- Use a clean, soft, dry cloth to gently wipe dust and dirt from the screen.
- Do not use benzene, thinner, car cleaner, or other cleaners. These substances may damage the monitor system or cause the paint to peel.
- The surface of the LCD can be easily scratched. Do not rub it with anything abrasive.

Servicing the monitor

In the event that trouble arises, never open the monitor case, disassemble the player or attempt to repair it yourself. The internal parts are not serviceable by the user. Opening any components will void the warranty. All warranty service should be performed by an authorized Clarion service center.



CAUTION!

Changes or modifications to this product not approved by the manufacturer will void the warranty and will violate FCC approval.

Cleaning the remote control

Use only a clean, soft, damp cloth to clean the remote control. Do not use lighter fluid, methyl alcohol or other solvents.

Cleaning discs

Before playing a disc, wipe it outwards from the center with a clean, soft cloth.

Changing the battery in the remote control

The battery needs changing when the buttons on the remote stop working or when you have to move closer and closer to the player for the remote to work

Precautions

- Dispose of used batteries properly.
- Do not dispose of used batteries throwing them into fire. If you do so, they may explode.
- Do not short the positive (+) and negative (-) terminals.
- Keep the battery and its holder away from young children. They may choke on the battery while attempting to swallow or chew on it.

Procedure***Note:***

The battery type must be CR2025. Do not replace with any other battery type.

1. Turn the remote up-side-down.
2. Simultaneously slide the battery latch in the direction of the arrow and pull the battery holder out of the slot.

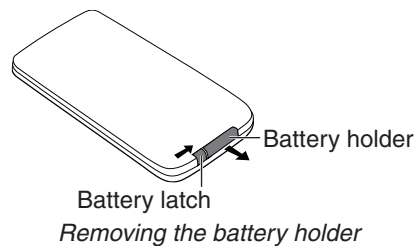

3. Remove the old battery.



4. Place the new lithium battery in the slot with the plus (+) side up.
5. Push the battery holder back into the slot until it locks in place.

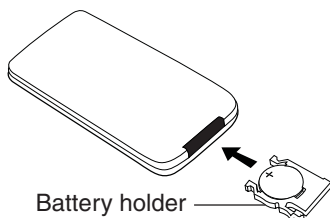

*Battery with
the plus side
up*

Inserting the holder with the battery into the remote control

5. INSTALLATION AND WIRING

Do not attempt to install or service your player yourself. Installation and servicing require experience in electronic equipment and automotive accessories. If you do not have the knowledge or experience this installation may be dangerous and could expose you to the risk of electric shock or other hazards.

Read these instructions and precautions carefully. Improper installation can damage the monitor and the vehicle.

What is included in the box

In addition to this manual, the box contains:

- 1 Player
- 1 IR remote control with battery
- 1 Audio/video RCA cable
- 6 ST4.2 x 16 screws
- 4 CM 4 x 8 screws
- 1 Metal mounting plate
- 1 Rubber gasket

Note:

Use only the contents of this package to install and use the DVD player. Using accessories not provided with this player may damage the player.



Tools and additional components

You will need a Phillips-head screwdriver when mounting the player in the vehicle.

Before you begin

1. Verify that the vehicle electrical components function, including: power windows, power door locks, air conditioning, lights, etc.
2. Identify the polarity of the dome light circuit and set the switch on the bottom of the overhead monitor housing.
3. Test fit the location of the overhead monitor system to ensure it will not interfere with the operation of the vehicle.
4. If applicable, verify that the monitor, when mounted, will not interfere with the operation of the sun roof.
5. Carefully mark the location with masking tape.
6. Lower the vehicle's headliner down to see if a roof support beam is available to screw the mounting bracket to.

If a support beam is not available, use a 3/4-inch piece of plywood cut to the appropriate size. Attach the plywood to the roof of the vehicle using silicone. Allow for adequate drying time.

7. Determine the location of any additional audio/video sources.
8. Disconnect the negative battery terminal before making any wiring connections.

CAUTION

Do not open the case. There are no serviceable parts inside. If you drop anything into the unit during installation, consult with your Clarion Dealer or an authorized Clarion service center.

Mounting and wiring precautions

The OHM875VD / OHM1075VD / OHM1575VD should be mounted in the ceiling of the vehicle. The front panel controls should be easily accessible from the rear seat. In addition:

- This unit is exclusively for vehicles with a negative ground, 12V power supply.
- This unit may be installed with additional mobile audio components, such as a digital camera.
- Always use great care when attaching anything to a vehicle! Check clearances on both sides of the planned installation before drilling any holes or installing any screws.
- A good chassis ground connection is critical to minimize resistance and avoid noise problems. Use the shortest wire possible and securely connect it to the car chassis and the source unit ground.



- When routing RCA cables, keep them away from the power cables and output speaker wires, engine, exhaust system, etc. Heat may damage wires.
- If the fuse should blow, make sure that all connections are correct, the cables have not caused a short circuit, and no wires are damaged. Then replace the fuse with a new fuse of the same amperage value as the original fuse. When replacing a fuse, never let the battery side touch any metal part or any other wire.
- Never let disconnected cables or terminals touch metal on the car or any other conducting material.
- To prevent short circuits, do not remove the caps from unused terminals or from the ends of unconnected cables.
- Insulate unconnected wires with vinyl tape or other similar material.

WARNING!

To prevent short circuits during installation, disconnect the vehicle's negative (-) battery lead before making any power connections.

Installation procedure

The OHM875VD / OHM1075VD / OHM1575VD replaces the car's dome light. This section provides basic tips and techniques to aid the installation. These are not vehicle specific, but should be used as guidelines for performing the installation.

Set the polarity switch

1. Determine the polarity of the power system in the car. This information should be on a vehicle-specific diagram.
2. Locate the polarity switch on the back of the player (the side that will be attached to the ceiling).

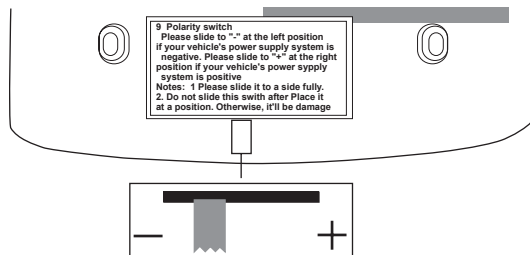

Back of the player

3. If the vehicle's power supply requires negative polarity, slide this switch to the negative (-) position. Otherwise, slide this switch to the positive (+) position.



CAUTION

Make sure the switch is fully to one side or the other. Do not attempt to configure this switch once the player is in position.

4. Cut a one-inch hole in the headliner along the backside of the ceiling bracket for the cables to pass through.

Install the ceiling bracket and cables

1. Disconnect and remove the original dome light.
2. Screw the metal mounting plate to the beam or plywood using the six ST4.2 x 16 screws.

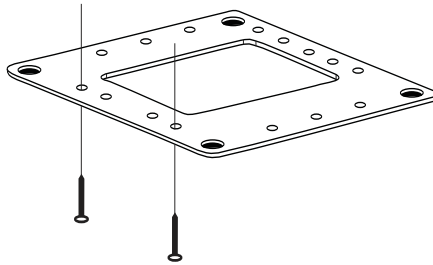

Metal mounting plate showing screw positions

Note:

Do not cover the original dome light opening.

Connect cables

1. Pull out the original dome light's power wire and signal/power cable through the original dome light opening.
2. Place the rubber gasket on the player.

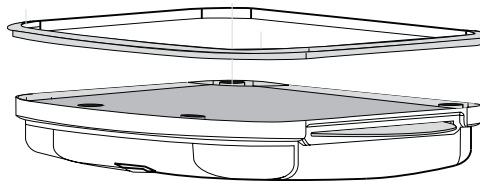

Placing the rubber gasket on the player



3. Route the cables through the hole to the location of any audio/video sources.
4. Identify the dome light wires in the vehicle and connect them to the corresponding dome light wire on the overhead monitor system.
5. Plug in any audio/video source cables.
6. Plug in the power harness into the overhead monitor system in the following order: ground wire, battery wire, ACC wire and door wire.

Note:

*Do not forget to connect the red ACC wire to the ignition switch.
If you do not connect this wire, the battery charge may drain off prematurely.*

Install the monitor

1. Carefully hold the overhead monitor up to the metal mounting plate.
2. Screw in the four CM 4 x 8 screws making sure the wires are not in the way.

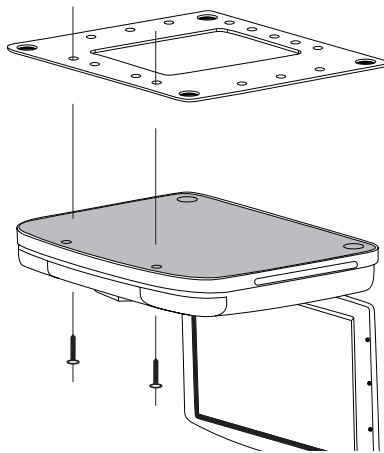

Mounting the player

3. Reconnect the battery.
4. Check the car's brake lights, blinkers, wiper, etc. to ensure they are working properly.





English

Wiring diagram

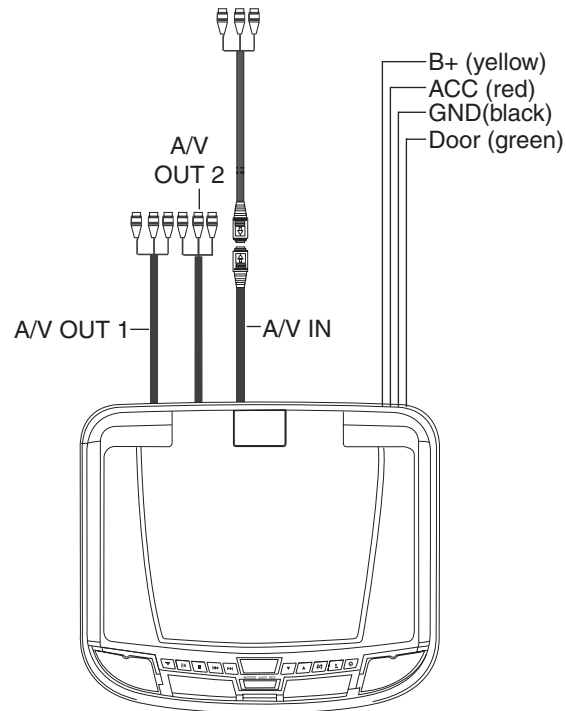

Top of the unit showing cable connections

6. SETTING PREFERENCES

Accessing the on-screen display menus

1. Press **SETUP** on the remote to access the OSD menus.

The main Display menu appears.



General setup page





- Press ◀ (left arrow) and ▶ (right arrow) to alternate among three option pages: GENERAL SETUP PAGE, SPEAKER SETUP PAGE and PREFERENCE PAGE.

Note:

To access the PREFERENCE PAGE the DVD slot must be empty.
Eject any DVD or CD in the drive.

- Press **ENTER** to select the option you wish to change.
- Press **ENTER** to confirm your selection.
- Press **SETUP** to exit the on-screen display menus.

Example: Setting parental control

- Press **SETUP**, then press ▶ (right arrow) to display the PREFERENCE PAGE.

The system displays the OSD menu.

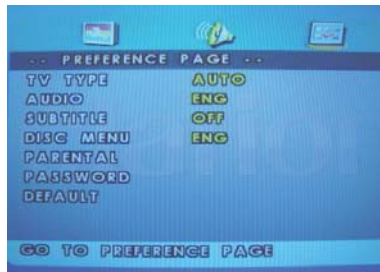

Preference page

- Press ▼ five times to select **Parental**.
- Press ▶ to increase and ◀ to decrease the level of parental control between “1” and “8” with “8” providing the most control.
- Press **ENTER** to save this preference.
The player prompts you for the password.
- Type the password and press **ENTER** again to confirm the password.
- Press **SETUP** to exit the on-screen display menus.





General setup page

This page controls standard DVD options.

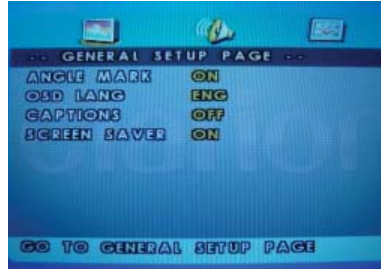

General setup page

Setting

Value and Description

ANGLE MARK

Turns multiple-angle feature on and off. Multiple angles must be pre-recorded on the DVD. To determine if the DVD supports multiple angles, look for the multiple-angle symbol on the disc jacket (Ⓜ).

ON Enables the use the **ANGLE** button to select a different angle for the current scene.

OFF Disables the **ANGLE** button.

OSD LANG

Selects the language for the on-screen display menus.

ENGLISH, FRENCH, SPANISH

CAPTIONS

Turns captions on and off.

ON Enables captions.

OFF Disables captions.

SCREEN SAVER

Turns the screen saving feature on and off.

ON Enables the screen saver feature.

OFF Disables the screen saver feature.





Speaker setup page

This page controls speaker options.



Speaker page

DOWNMIX

Applies to Dolby digital sound. You cannot change this option, which is permanently set to output stereo signals, that is the player outputs audio to both the left and right channels of the output RCA jacks.

Preference page

This page controls system-wide preferences.

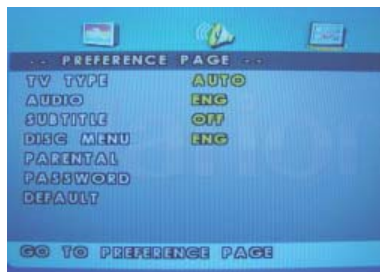

Preference page

TV TYPE

Selects the TV system. Changing this option also changes the RCA AV output.

PAL For Europe and Asia

NTSC For the United States

AUDIO

Selects the audible language for the DVD audio track.

ENGLISH, FRENCH, SPANISH

SUBTITLE

Selects the language for subtitles.

ENGLISH, FRENCH, SPANISH

OFF Turns subtitles off.





English

DISC MENU

Selects the language to display the contents of the current disc.

ENGLISH, FRENCH, SPANISH

PARENTAL

Restricts movie viewing to appropriate ages.

- 1 (KID SAF)** Material is safe for children.
- 2 (G)** Material is safe for general audiences.
- 3 (PG)** Parental guidance suggested.
- 4 (PG 13)** Some material unsuitable for children under 13.
- 5 (PGR)** Some material unsuitable for children under 17.
- 6 (R)** Some material unsuitable for children under 17.
- 7 (NC 17)** Not recommended viewing for children under 17.
- 8 (ADULT)** Only for adults due to the graphic content. This is the default setting.

Note:

After setting parental control, the player prompts you for the system password.

PASSWORD

Lets you change the four-digit password using the number keys on the remote. The default password is 3308, but it no longer works once you change the password.

DEFAULT

Resets all values to their factory defaults.

7. TROUBLESHOOTING

If operations freeze, the screen goes blank, or the player otherwise does not function properly, try turning it off and back on again. If it still does not respond, press the reset switch on the front panel.

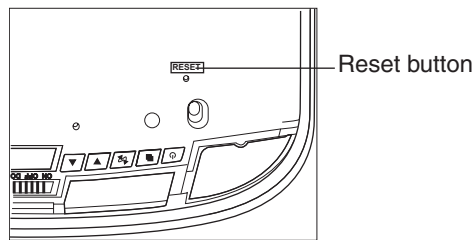

Player with the monitor open

Player does not turn on

- The car's ignition may be off. Turn on the ignition to the ACC (Accessory) position.
- The player may not be on. Turn the player's power on.





- There may be condensation in the player. Wait for about one hour or until the condensation evaporates.
- A fuse may be blown. Check the fuses at the end of the monitor installation cables and on the vehicle.
- The player may be disconnected. Check all connections. See the installation instructions.
- The remote control battery may require changing.
- Dirt may be covering the remote's infrared lens. Clean the lens with a soft damp cloth.

Player is on but won't play the disc

- The disc may be inserted incorrectly. Reinsert the disc with the label side up (facing the ceiling of the car).
- The disc format may not be supported. The player supports these formats:

	DVDs	12cm
	Vedio CDs	12cm
	Audio CDS	12cm
	MP3 CDs	12cm

- The disc may be dirty or scratched. Clean or replace the disc.

The player suddenly stops working

- There is an error in the player. Turn the player off and on again. If it still doesn't respond, press the **RESET** button.

The player works erratically

- The remote control battery needs replacing.
- The IR window on the player or remote control is dirty. Clean the IR windows with a soft damp cloth.
- The connections are loose. Check and tighten all connections.

The picture occasionally skips

- The disc is dirty or scratched. Clean or replace the disc.

The picture is blurred

- You may be passing near a high voltage wire, transformer, aircraft or other source of electrical interference. The picture will improve when you move away from the source interference.





English

The picture is very dark

- The temperature in the car is very low. At low temperatures LCD screen display dark pictures. The picture will improve as the temperature rises.
- The brightness is set too high. Adjust it lower. Press the **MENU** button on the remote or on the player.

No sound can be heard from the IR wireless headphones

- The headphones are not turned on.
- The battery in the headphones is low. Replace the battery.
- An object is blocking the transmission of the infrared signal from the player to the headphones or the headphones are beyond the reach of the IR signal. The IR receiver on the headphones must be in direct line of sight of the IR transmitter on the player.

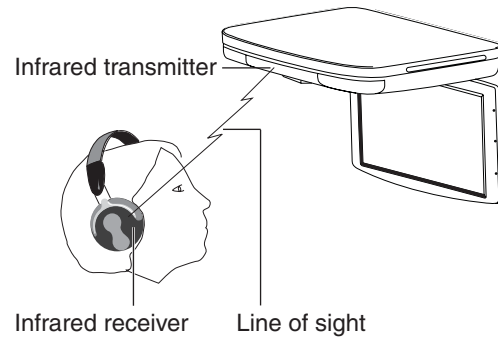

IR line of sight from the player to the headphones





8. GLOSSARY

Active matrix: A flat panel display technology that produces a brighter and sharper display and a broader viewing angle than passive matrix panels. Each pixel has its own thin film transistor (TFT) and is sometimes called a “TFT screen.”

Aspect ratio: The comparison of the width to the height of an object.

Audio/video (A/V) source: Any additional audio and/or video device that has a composite RCA output, such as a game player, VCR, digital camera, etc.

CD: Compact Disc.

CD-R/RW: CD Read/Read and Write.

Display angle: The extent to which the LCD screen can be opened (180 degrees).

Dolby Digital: The marketing name for the audio compression technologies developed by Dolby Laboratories.

DVD: Digital VideoDisc or Digital Versatile Disc.

DVD-R: DVD Read only.

DVD-RW: DVD Read and Write.

JPEG/JPG: Joint Pictures Expert Group, the committee that developed the standards for compressing graphics, especially photographs.

IR: infrared.

NTSC: National TV Standards Committee, the group that developed the television standards used in the United States.

LCD: Liquid Crystal Display, the technology used for laptop and other small computer monitors.

MP3: MPEG Audio Layer-3, a standard for sound compression without sacrificing quality.

OSD: on-screen display.

PAL: The primarily European standard for displaying analog television signals.

Pixel: Short for picture element, the smallest point on a graphic image or monitor.

Thin film transistor (TFT): The display technology in which thin films are deposited during the manufacturing process to create metallic contacts.

SRC: Source.

VCD: Video CD, the standard for storing video on a CD.

Viewing angle: Pre-recorded alternative angles for individual scenes.

WVGA: Wide Angle Video Array, the number of pixels in each direction that can be displayed on a monitor.



9. SPECIFICATIONS

	OHM875VD	OHM1075VD	OHM1575VD
Power supply (car battery)	12V DC (10V-16V)		
Test voltage	14V, negative ground		
Operating current	<1.3A	<1.5A	
Current consumption	<6mA		
Max current consumption	<1.8A	<2A	
Mechanism	Manual open and close		
Video system	Auto, NTSC and PAL		
Screen	8" diagonal	10.2" diagonal	15.4" diagonal
Resolution	800 x 480		1024x768
Display angle	Vertical adjustable up and down; maximum angle 180°		
Viewing angle (up/down/left/right)	45/65/65/65		10/30/40/40
Weight	4.313 lbs (1.95 kg)	4.959 lbs (2.25kg)	
Video signal	1Vp-p, 75-Ohm load		
Operating temperature	-5 ~ 55° C		
Storage temperature	-20 ~ 70° C		
Dome light	2W		

Note:

For the sake of technical improvements, this technical data and the design of the equipment may change without prior notice.



Clarion®

CLARION 2007 LIMITED WARRANTY

For USA and Canada only

Except as noted, Clarion products purchased from an authorized Clarion dealer are warranted against all defects in materials and workmanship for a period of one (1) year from the date of original purchase. The following Clarion products noted below ** are warranted against all defects in materials and workmanship for a two (2) year period from the date of original purchase when purchased from AND installed by an authorized Clarion dealer.

****DRZ9255 DXZ775USB DXZ675USB DXZ575USB DFZ675MC DPX11500 DPX1800 DPX2250**

All Clarion cables, wires and other accessories if purchased from an authorized Clarion dealer are warranted against all defects in materials and workmanship for ninety (90) days from the date of original purchase.

ALL PURCHASES OF CLARION PRODUCTS FROM NON-AUTHORIZED CLARION DEALERS ARE SUBJECT TO FURTHER WARRANTY RESTRICTIONS AS DESCRIBED BELOW.

The conditions of this Limited Warranty and the extent of responsibility of Clarion Corporation of America ("Clarion") under this Limited Warranty are as follows:

1. **PROOF OF DATE OF PURCHASE FROM AN AUTHORIZED CLARION DEALER WILL BE REQUIRED FOR WARRANTY SERVICE OF THIS PRODUCT. IN THE CASE OF THE TWO (2) YEAR LIMITED WARRANTY FOR THE CLARION PRODUCTS NOTED ABOVE, PROOF OF DATE OF PURCHASE AND PROOF OF INSTALLATION BY AN AUTHORIZED CLARION DEALER IS REQUIRED. INFORMATION ABOUT CLARION AUTHORIZED WARRANTY SERVICE CENTERS MAY BE OBTAINED BY CONTACTING CLARION AT THE ADDRESS LISTED BELOW.**
2. This Limited Warranty will become void if service performed by anyone other than an approved Clarion Warranty Service Center results in damage to the products.
3. This Limited Warranty does not apply to any product which has been subject to misuse, neglect or accident, or which has had the serial number altered, defaced or removed, or which has been connected, installed, adjusted or repaired, other than in accordance with the instructions furnished by Clarion.
4. This Limited Warranty does not cover car static or other electrical interferences, tape head or laser pick-up cleaning or adjustments, or labor costs for the removal or reinstallation of the unit for repair.
5. The sole responsibility of Clarion under this Limited Warranty shall be limited to the repair of the products or replacement of the product, at the sole discretion of Clarion.
6. Product must be shipped in its original carton or equivalent carton, fully insured, with shipping charges prepaid. Clarion will not assume any responsibility for any loss or damage incurred in shipping.
7. **CLARION PRODUCTS PURCHASED FROM A SOURCE OTHER THAN AN AUTHORIZED CLARION DEALER, INCLUDING ANY AND ALL PURCHASES VIA THE INTERNET FROM A NON INTERNET AUTHORIZED CLARION DEALER, SHALL NOT BE COVERED BY ANY CLARION LIMITED WARRANTY TO THE EXTENT ALLOWED BY APPLICABLE LAW. IN THE EVENT AND TO THE EXTENT APPLICABLE LAW PROHIBITS ELIMINATION OF WARRANTIES UNDER THESE CIRCUMSTANCES, THE APPLICABLE LIMITED WARRANTY PERIOD SHALL BE DEEMED TO BE FIFTEEN (15) DAYS FROM THE DATE OF ORIGINAL PURCHASE.**
8. **ALL IMPLIED WARRANTIES EXCEPT TO THE EXTENT PROHIBITED BY APPLICABLE LAW SHALL HAVE NO GREATER DURATION THAN THE WARRANTY PERIOD SET FORTH ABOVE. UNDER NO CIRCUMSTANCES SHALL CLARION BE LIABLE FOR ANY LOSS OR DAMAGE, DIRECT OR CONSEQUENTIAL, ARISING OUT OF THE USE OR INABILITY TO USE THE PRODUCT. BECAUSE SOME STATES DO NOT ALLOW LIMITATIONS ON HOW LONG AN IMPLIED WARRANTY LASTS OR EXCLUSIONS OR LIMITATIONS OF INCIDENTAL OR CONSEQUENTIAL DAMAGES, THE ABOVE LIMITATIONS OR EXCLUSIONS MAY NOT APPLY TO YOU.**
9. **THIS LIMITED WARRANTY GIVES YOU SPECIFIC LEGAL RIGHTS, AND YOU MAY ALSO HAVE OTHER RIGHTS WHICH VARY FROM STATE TO STATE.**
10. The laws of the State of California shall govern and control this limited warranty, its interpretation and enforcement.
11. Should you have any difficulties with the performance of this product during the warranty period, please call Clarion or visit our web site for a listing of Authorized Warranty Service Centers in your area. You may also contact the Clarion Customer Service at the address listed below for any service help you may need with Clarion products.

In USA:
 Clarion Corporation of America
 Attn: Customer Service Manager
 6200 Gateway Drive
 Cypress, CA 90630
 1-800-GO-CLARION
 www.clarion.com

In Canada:
 Clarion Canada Inc.
 Warranty Service Center
 2239 Winston Park Drive
 Oakville, Ontario L6H 5R1
 (905)829-4600
 www.clarioncanada.com





Clarion Corporation of America

All Rights Reserved. Copyright © 2006: Clarion Corp. of America
Printed in China

